

Product Outlook

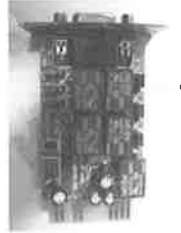

Top View



Side View



Top View



Side View

9-pin port

Product Introduction

The AS400 communication card provides contact closures for remote monitoring your UPS. To get different application requirement, the AS400 card is capable of selection the status of the -contact signal (active close or active open) by setting jumper. The suitable applications are listed below:

- IBM Server, Personal PC & Workstations equipments
- Auto-controlled industrial equipment & communication applications

Installation

Step 1: Remove cover of Intelligent Slot on the rear panel of the UPS. **Step 2:** Insert AS400 card into Intelligent Slot.



Step 3: The cover of AS400 should attach close to the rear panel. Using screwdriver, secure the AS400 to the UPS chassis with 2 screws. **Step 4:** Use the 9-pin communication cable to connect UPS and equipment to implement the remote monitoring and control.

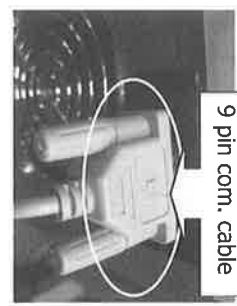

4. Specifications

Internal circuit of DB-9 port

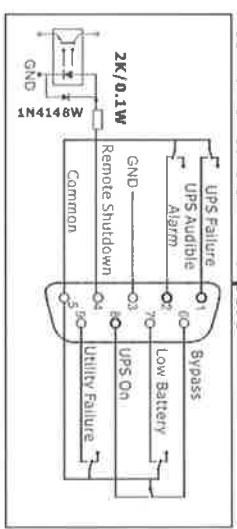

RS-232 port

Electric Parameter of DB-9 port

Parameter	Symbol	Max.	Min.	Unit
Resistor*	I_r	6	1	mA
Diode	DC Current	6	-	V
	Reverse Voltage	VR	-	mA
Relay	Forward Current	IF	-	A
	Peak Forward Current	I_f (peak)	-	V
DC Voltage	Vdc	24	-	V
DC Current	Idc	1.0	-	A

Note: It's required to retain the DC current lower than 6mA. Otherwise, it's necessary to add one resistor within DC current limitation in the serial loop of Remote Shutdown. (e.g. 2K resistor with at least 0.1W rating power). Refer to diagrams in **Application**.

Pin Assignment

Pin Assignment	Function	I/O
Pin 1	UPS Failure	O/P
Pin 2	UPS Audible Alarm	O/P
Pin 3	GND (Common for Pin 4)	Power Ground
Pin 4	On/Off	I/P
Pin 5	Common for Relays	Power Supply
Pin 6	Bypass Active	O/P
Pin 7	Low Battery	O/P
Pin 8	UPS On	O/P
Pin 9	Utility Failure	O/P

P.S. The ON/OFF function pin (pin4 & pin3) accepts more than 2s high level signal to perform UPS on and off actions.

Function Description

AC Status	AO Status	Reason
Pin 1 & Pin 5 connected	Pin 1 & Pin 5 disconnected	UPS failure
Pin 2 & Pin 5 connected	Pin 2 & Pin 5 disconnected	UPS failure, utility failure, low battery, bypass active
Pin 6 & Pin 5 connected	Pin 6 & Pin 5 disconnected	Bypass active
Pin 7 & Pin 5 connected	Pin 7 & Pin 5 disconnected	Battery voltage is low
Pin 8 & Pin 5 connected	Pin 8 & Pin 5 disconnected	UPS is in inverter mode
Pin 9 & Pin 5 connected	Pin 9 & Pin 5 disconnected	Utility failure

9-pin port

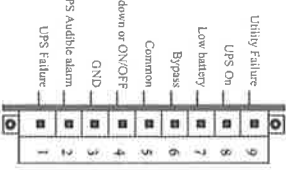

Application:

Below shows the circuit of basic application to implement monitoring and control.

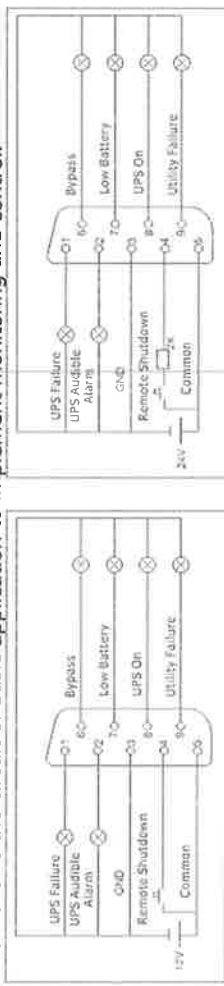

User Interface for 12 V

User Interface for 24 V

5. Internal Logical Connection

IC controller of the card controls actions of 5 relays depending on the UPS status. Active-Close(A.C) terminal and Active-Open(A.O) terminal of each relay connect to pin 3 and pin 1 of a 3-pin connector respectively. The pin 2 of the 3-pin connector connects to the signal pin of the DB9 interface connector. The 2-pin jumper can be plugged to the 3-pin connector to either short-circuit Pin1 & Pin2(A.C) or short-circuit Pin3 & Pin2(A.O).

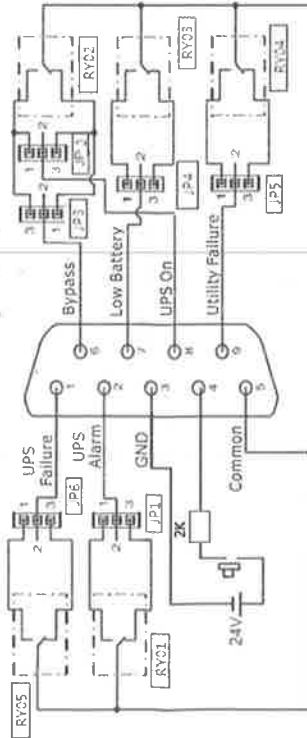

Fig 1 Pin definition and internal logical connection

Accordingly, if pin1 short-circuits with pin2 via the jumper, the status of dry contact signal will be ACTIVE CLOSE, refer to Fig 2. When the signal is active, the signal pin on the DB9 connector will connect with the common pin (pin5) via the relay.

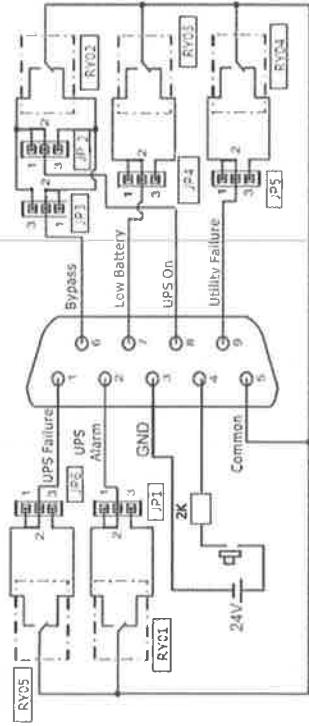

Fig 2 Connection for ACTIVE CLOSE

If Pin3 short-circuit with Pin2(A.O) via the jumper, the status of dry contact signal will be ACTIVE OPEN, refer to Fig 3. When the signal is active, the signal pin on the DB9 connector will disconnect with the common pin (pin5) via the relay.

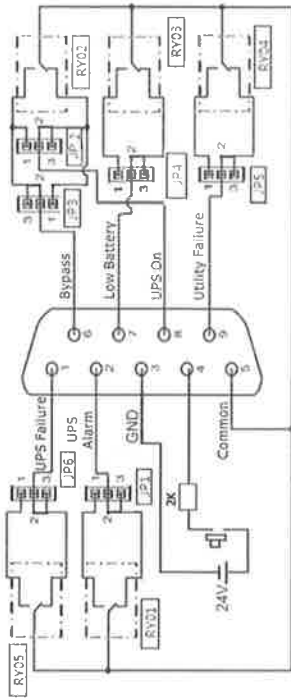

Fig. 3 Connection for ACTIVE OPEN

6 Jumper Set-up

The 3-pin connectors can be easily found just near to the relay. Refer to Fig. 4.



Fig.4 AS400 card

There are AC and AO white silk printings of the connector as shown in Fig. 5 to indicate pin1&2 in A.C and pin2&3 in A.O.



Fig. 5 AO and AC silk printings indicates each 3-pin connector status
To achieve ACTIVE OPEN dry-contact signal, the jumper should connect the middle pin and the pin3 as shown in Fig. 7

To achieve ACTIVE CLOSE dry-contact signal, the jumper should connect the 2 pins(Pin1&2) as shown in Fig. 6.



Fig. 6 Jumper setting for ACTIVE CLOSE



Fig. 7 Jumper setting for ACTIVE OPEN

Jumper function description

JP	Description	JP	Description
1	UPS alarm (DB9.P2)	4	Low battery(DB9.P7)
2	UPS on(DB9.P8)	5	Utility failure(DB9.P9)
3	Bypass(DB9.P6)	6	UPS failure(DB9.P1)